





















# Bellevue

Designed inhouse and crafted to exacting standards, the solid brass Bellevue range is perfectly at home in the most impressive interiors. Available in five exquisite finishes and the option of a plain, lined or knurled texture. This range also includes an appliance pull, the perfect statement piece in a premium kitchen.



PLAIN HANDLES	Knob: BVKPL035   160mm Bar Pull: BVPPL160   320mm Bar Pull: BVPPL320 Appliance Pull: BVAPPL416									
LINED HANDLES	Knob: BVKLD035   160mm Bar Pull: BVPLD160   320mm Bar Pull: BVPLD320 Appliance Pull: BVAPLD416									
KNURLED HANDLES	Knob: BVKKN035   160mm Bar Pull: BVPKN160   320mm Bar Pull: BVPKN320 Appliance Pull: BVAPKN416									
BACKPLATES	Knob: BVPLBP035   160mm Bar Pull: BVPLBP160   320mm Bar Pull: BVPLBP320 Appliance Pull: BVPLBP416									
FINISHES	<table border="0"> <tr> <td> Brushed Satin Brass (BSB)</td> <td> Dull Brushed Nickel (DBR)</td> <td> Matt Black (MBL)</td> </tr> <tr> <td> Dark Brushed Brass (DBB)</td> <td> Dark Bronze (DKB)*</td> <td> Bronze (BNZ)</td> </tr> <tr> <td></td> <td> Gunmetal (GNM)*</td> <td></td> </tr> </table>	 Brushed Satin Brass (BSB)	 Dull Brushed Nickel (DBR)	 Matt Black (MBL)	 Dark Brushed Brass (DBB)	 Dark Bronze (DKB)*	 Bronze (BNZ)		 Gunmetal (GNM)*	
 Brushed Satin Brass (BSB)	 Dull Brushed Nickel (DBR)	 Matt Black (MBL)								
 Dark Brushed Brass (DBB)	 Dark Bronze (DKB)*	 Bronze (BNZ)								
	 Gunmetal (GNM)*									

\*Only Knurled range is available in Dark Bronze

\*Only Lined and plain ranges available in Gunmetal

## Knob

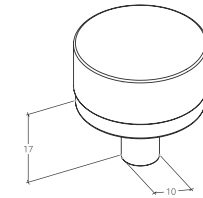
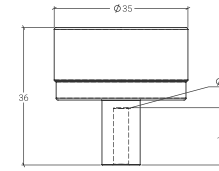

**MO  
MO  
HANDLES**

## Bar Pull

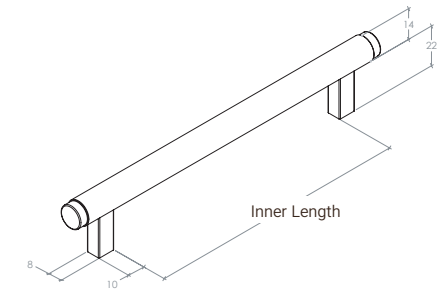
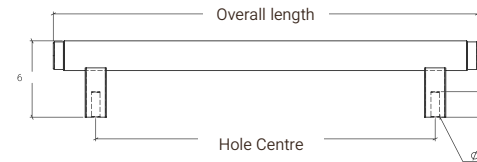

## Appliance Pull

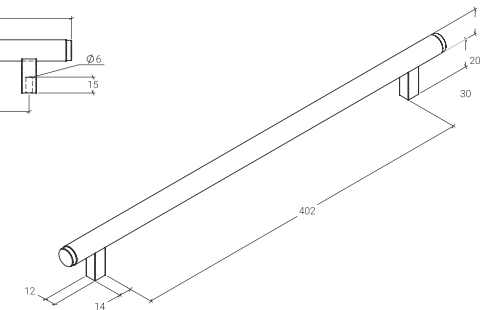
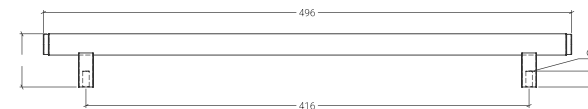

Part Number	Hole Centre	Overall Length	Inner Length	Projection
BVKPL035   BVKLD035   BVKKN035	-	35Ø	-	36
BVPKN160   BVPPL160   BVPLD160	160	200	150	36
BVPKN320   BVPPL320   BVPLD320	320	370	310	36
BVAPPL416   BVAPLD416   BVAPKN416	416	496	402	50